

PIN CONFIGURATION

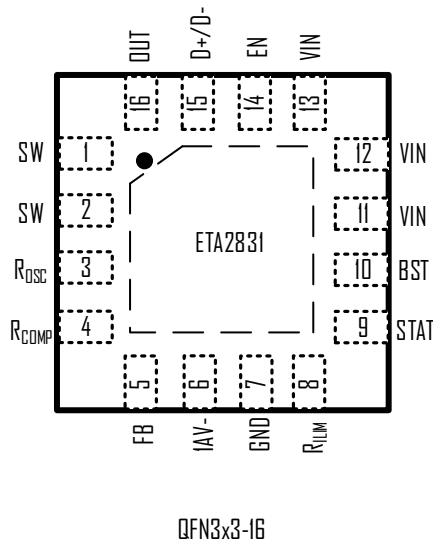

ABSOLUTEMAXIMUM RATINGS

(Note: Exceeding these limits may damage the device. Exposure to absolute maximum rating conditions for long periods may affect device reliability.)

IN Voltage	-0.3V to 42V
SW, EN Voltage	-0.3V to VIN+0.3V
BST Voltage	-0.3V to SW+6V
Other Pins Voltage.....	-0.3V to +6V
SW to ground current.....	Internally limited
Operating Temperature Range	-40°C to 85°C
Storage Temperature Range	-55°C to 150°C
Thermal Resistance	θ_{JA}
QFN3X3-16.....	50 °C/W
Lead Temperature (Soldering, 10ssec)	260°C
ESD HBM (Human Body Mode)	2KV
ESD MM (Machine Mode)	200V

ELECTRICAL CHARACTERISTICS

(VIN = 12V, unless otherwise specified. Typical values are at TA = 25°C.)

PARAMETER	CONDITIONS	MIN	TYP	MAX	UNITS
Input Standoff Voltage		42			V
Input Voltage Range		4		36	V
Input UVLO	Rising. Hysteresis=150mV		3.80		V
Input OVP	Rising. Hysteresis=1.5V		37.5		V
Input Supply Current	VFB=0.85V, no switching		0.85	1	mA
Input Shutdown Current			6		μA
FB Voltage		0.776	0.800	0.824	V
FB Input Current		-1	0	1	μA
Switching Frequency	ROSC=200KΩ		500		KHZ
FoldBack Frequency	VFB=0, ROSC=200KΩ		125		KHZ
Maximum Duty Cycle	fOSC < 600KHZ	90			%
High side Switch On Resistance	ISW=200mA		100		mΩ
High side Switch Current Limit	RILIM=250KΩ		4		A
SW Leakage Current	VIN=12V, VSW=0, EN= GND			10	μA
IAV- Drain Current Limit	VIAV-=0.2V	1.05	1.2	1.35	A
IAV- Lower Side NMOS On Resistance	IIAV- =1A		150		mΩ
IAV- Leakage Current	EN=GND	-1	0	1	μA
Short Circuit Hiccup time	ON		0.5		ms
	OFF		100		ms
EN Input Current	VIN=12V, VEN=5		0.1	5	μA

PARAMETER	CONDITIONS	MIN	TYP	MAX	UNITS
EN Input Low Voltage	Rising, Hysteresis=100mV	0.8	1.05	1.4	V
R _{DM1}	D+/D- output impedance at Divider Mode	28	39	50	k Ω
R _{DM2}	D+/D- output impedance at Samsung Mode	9	13	17	k Ω
Thermal Shutdown	Rising, Hysteresis=30°C		150		°C

PIN DESCRIPTION

PIN #	NAME	DESCRIPTION
1,2	SW	Inductor Connection. Connect an inductor between SW and the regulator output.
3	R _{OSC}	Frequency Setting. Connect a resistor from this pin to GND to set the switching frequency.
4	R _{COMP}	Cable Resistance Compensation adjust pin. Connect a resistor from this pin to GND to compensate for voltage drop due to cord resistance
5	FB	Feedback Input. Connect an external resistor divider from the output to FB and GND to set V _{OUT}
6	IAV-	Negative terminal of the IA port
7	GND	Ground
8	R _{LIM}	Current Limit Setting. Connect a resistor from this pin to GND to set the current limit value.
9	STAT	Status display. It is low resistance when there is heavy load.
10	BST	Bootstrap pin. Connect a 100nF capacitor from this pin to SW
11,12,13	VIN	Supply Voltage. Bypass with a 10 μ F ceramic capacitor to GND
14	EN	Enable pin for the IC. Drive this pin high to enable the part, low to disable.
15	D+/D-	Connected to the D+ and D- line of USB connect, provide the correct voltage with attached portable equipment for USB Dedicated Charging Port (DCP) Emulator.
16	OUT	Output Voltage.

APPLICATION INFORMATION

Peripheral Capacitor and Inductor Selection

Table 1 .Recommended Peripherals

Frequency (KHZ)	C _{in} (uF)	C _{out} (uF)	L(μ H)	V _{OUT} (V)
150	10	22x2	68-100	5
300	10	22x2	6.8-22	5
500	10	22x2	4.7-10	5
1000	10	22x2	2.2-4.7	5
2000	10	22x2	1.0	5

Setting the Switching Frequency

The ETA2831 uses a constant frequency PWM architecture that can be programmed to switch from 100kHz to 2MHz by using a resistor tied from the R_{OSC} pin to ground. A table showing the necessary R_{OSC} value for a desired switching frequency is below.

Table 2. SW Frequency vs R_{OSC} Value

$R_{OSC}(k\Omega)$	f(KHZ)
82	1000
100	857
150	574
220	400
330	282
390	241
470	200
680	140

Cable Resistance compensation

The ETA2831 has a cable cord resistance compensation feature to compensate the voltage drop due to cord resistance. The amount of added output voltage can be adjusted by an external resistor connected between R_{COMP} and GND pin.

Iout	Rcomp=150k	Rcomp=300k	Rcomp=510k
0	5.195	5.193	5.188
0.1	5.217	5.201	5.191
0.5	5.256	5.221	5.2
1	5.3	5.248	5.216
1.5	5.346	5.272	5.234
2	5.393	5.297	5.252
2.5	5.44	5.323	5.271
3	5.489	5.352	5.288

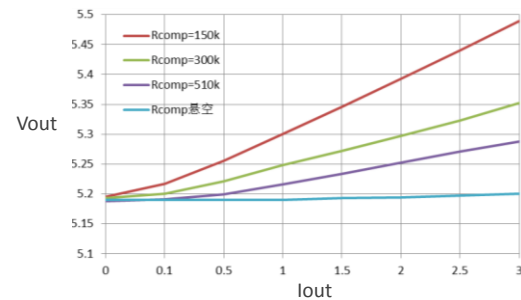

Setting of Output Current Limit

Given the input voltage, inductor value and oscillation frequency, the output current limit can be set by external resistor connected to R_{LIM} pin. Several typical current limit setting is listed in following table at $V_{in}=12V$, $f=300KHz$ and $L=6.8\mu H$.

Output Current Limit (A)	R_{LIM} (K)
1	1000
1.5	640
2	500
2.5	390
3	270
3.5	230
4	200

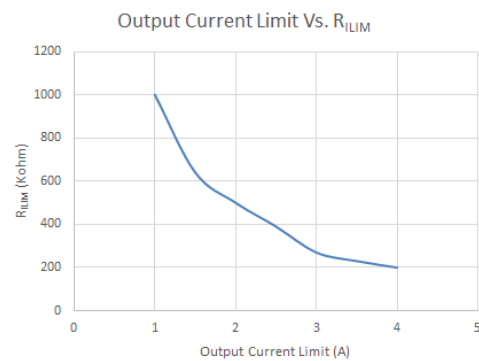

TYPICAL CHARACTERISTICS

($V_{in}=12V$, $V_{out}=5V$, $R_{comp}=510\Omega$ for cable resistance compensation, $T_A=25^\circ C$, unless otherwise specified)

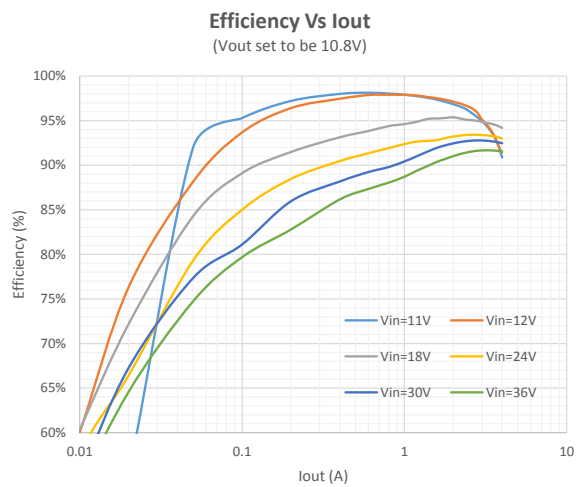
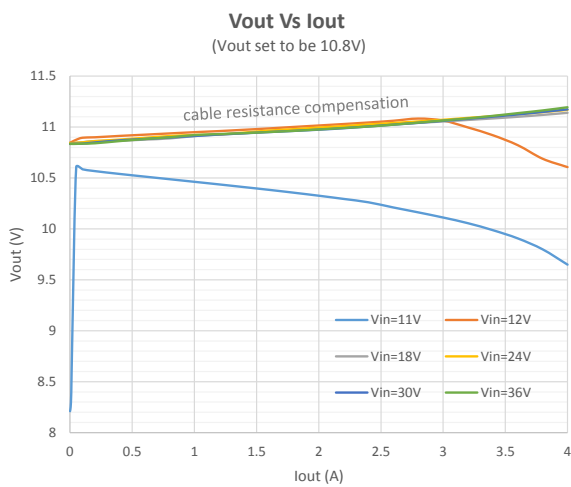
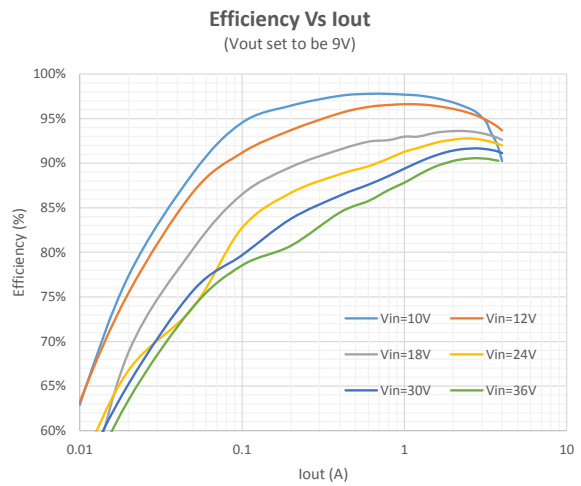
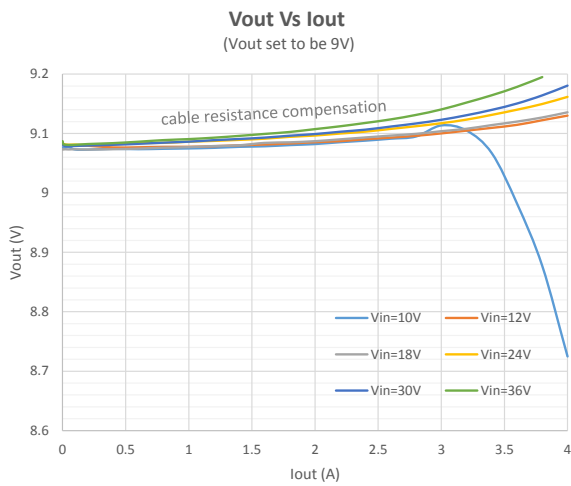
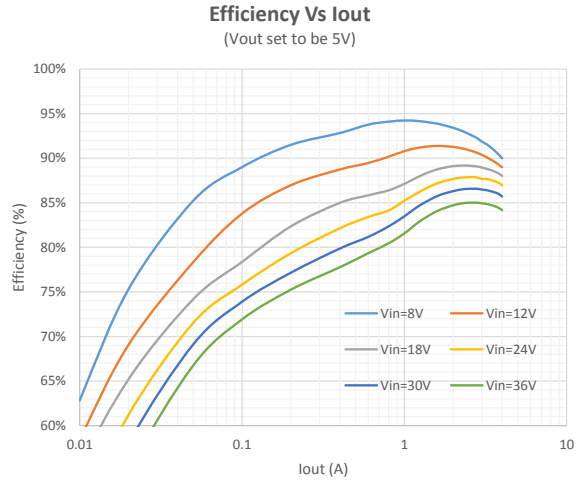
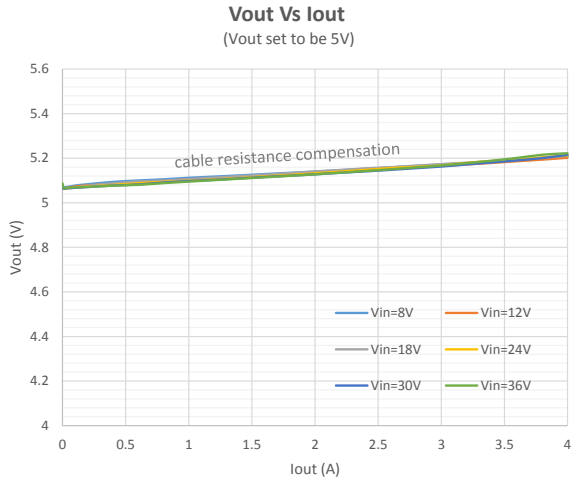

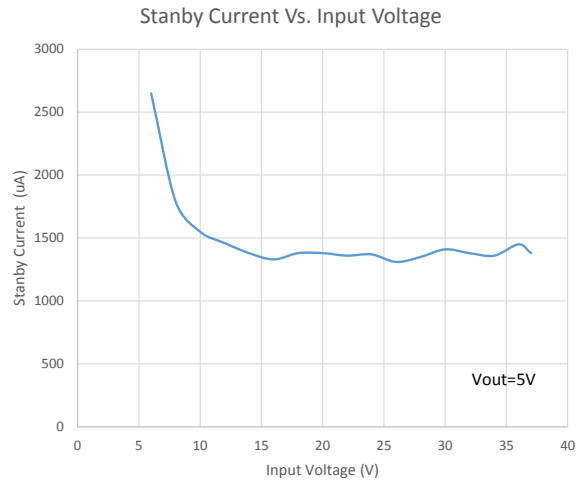
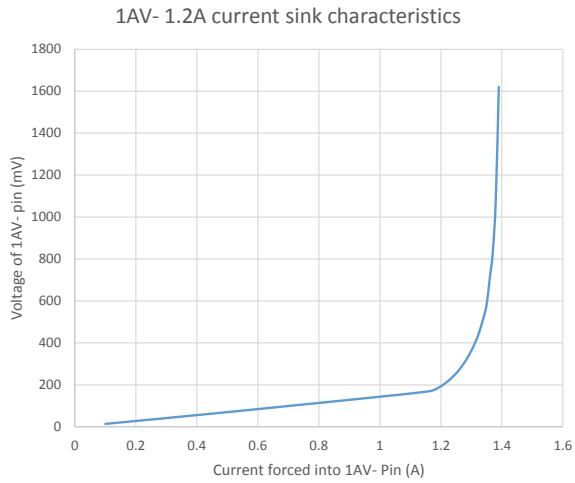

Output Current Limit Characteristic Vin=12V, Vout=5V, L=6.8uH, f=300KHz, Rcomp=510Kohm

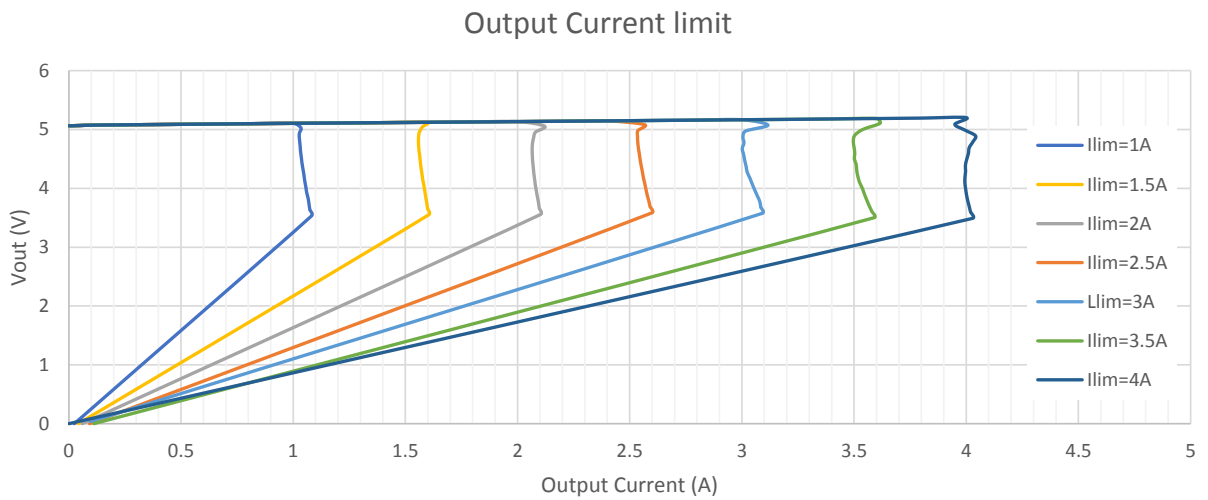

Heat Consideration and PCB Guideline

ETA2831 can deliver current up to 4A, and there will be a large amount of heat generated by the chip even though the efficiency is higher than 90% in most cases. Beside the ETA2831 itself, the 2 Schottky Diode (SBD) also generate a lot of heat. Please draw large heat sink area in PCB for ETA2831 and the 2 SBDs. In addition, 2 oz copper is recommended to be used on the PCB for better heat dissipation. Keeping SBDs and ETA2831 a little bit away from each other is also a good way to control the heat issue by having the heating source not too close to each other.

A picture of DEMO PCB is shown below. Please place the input capacitor (Cin1 and Cin2) as close to the chip as possible and placing this input capacitor is always the highest priority in drawing a PCB for ETA2831.

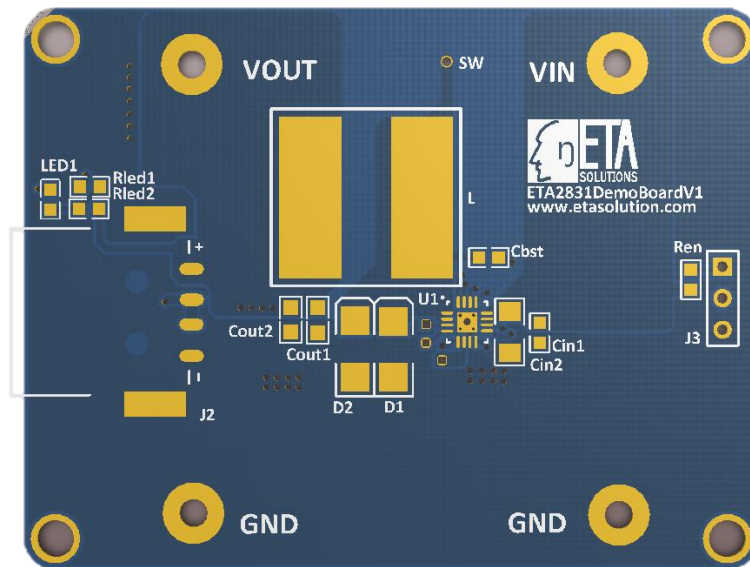

Package Outline

Package: QFN3*3-16

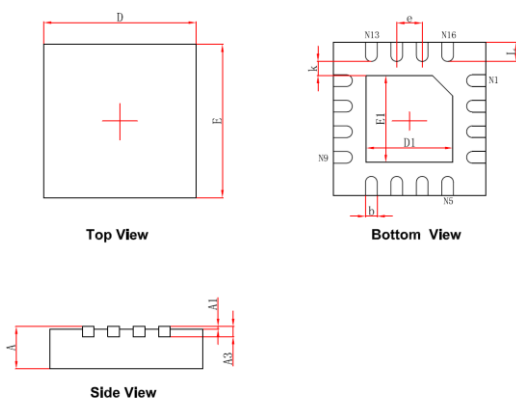

Symbol	Dimensions In Millimeters		Dimensions In Inches	
	Min.	Max.	Min.	Max.
A	0.700/0.800	0.800/0.900	0.028/0.031	0.031/0.035
A1	0.000	0.050	0.000	0.002
A3	0.203REF.		0.008REF.	
D	2.924	3.076	0.115	0.121
E	2.924	3.076	0.115	0.121
D1	1.600	1.800	0.063	0.071
E1	1.600	1.800	0.063	0.071
k	0.200MIN.		0.008MIN.	
b	0.180	0.280	0.007	0.011
e	0.500TYP.		0.020TYP.	
L	0.324	0.476	0.013	0.019