

18V/2A, High Efficiency Synchronous Step-Down Converter in SOT23-6

DESCRIPTION

ETA1477 is a wide input range, high-efficiency and high frequency DC-to-DC step-down switching regulator, capable of delivering up to 2A of output current. It adopts an Adaptive COT control scheme that enables very fast transient response and provides a very smooth transition when the output varies from light load to heavy load. During light load, ETA1477 goes into a PFM mode that saves switching loss achieving high efficiency. The adaptive COT control also maintains a constant switching frequency across line and load.

ETA1477 is available in SOT23-6 package.

FEATURES

- ◆ Wide Input Range: 4.5V-18V
- ◆ Adaptive COT Control
- ◆ Ultra-fast Load Transient Response
- ◆ High Efficiency PFM Mode at Light Load
- ◆ High Efficiency Synchronous Operation
- ◆ No Load IQ 177uA
- ◆ Low Rdson Internal Power FETs
- ◆ Capable of Delivering 2A
- ◆ No External Compensation Needed
- ◆ Thermal Shutdown and UVLO
- ◆ Available in SOT23-6 Package

APPLICATIONS

- ◆ LCD TV
- ◆ Set Top Box
- ◆ xDSL Modem

TYPICAL APPLICATION

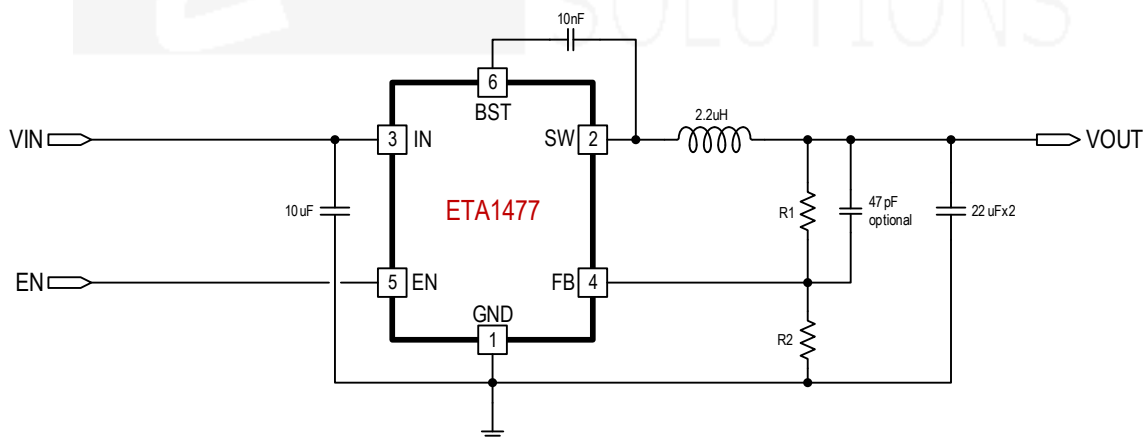

$$V_{out} = \frac{R1+R2}{R2} \times 0.768 \text{ (V)}$$

ORDERING INFORMATION

PART No.	PACKAGE	TOP MARK	Pcs/Reel
ETA1477S2G	SOT23-6	JBYW	3000

PIN CONFIGURATION

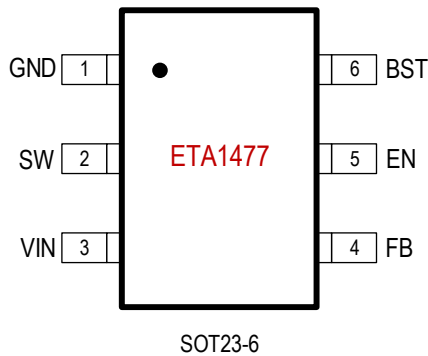

ABSOLUTE MAXIMUM RATINGS

(Note: Exceeding these limits may damage the device. Exposure to absolute maximum rating conditions for long periods may affect device reliability.)

- IN, SW, EN Voltage-0.3V to 24V
- BST Voltage-0.3V to SW+6V
- FB Voltage-0.3V to 6V
- Operating Temperature Range-40°C to 85°C
- Storage Temperature Range-55°C to 150°C
- Thermal Resistance θ_{JA} θ_{JC}
- SOT23-6.....180.....90..... °C/W
- Lead Temperature (Soldering 10sec).....260°C

ELECTRICAL CHARACTERISTICS

($V_{IN} = 12V$, $V_{OUT} = 3.3V$, unless otherwise specified. Typical values are at $T_A = 25^\circ C$.)

PARAMETER	CONDITIONS	MIN	TYP	MAX	UNIT
Input Voltage Range		4.5		18	V
Input UVLO	Rising, Hysteresis=320mV		4.05		V
Input Supply Current	$V_{FB}=0.85V$, no switching		177		μA
Input Shutdown Current			7	14	μA
FB Voltage		0.752	0.768	0.784	V
FB Input Current			0	0.05	μA
Switching Frequency			600		kHz
Maximum Duty Cycle			90		%
Startup Time			650		μS
Short Circuit Hiccup Time	On Time		1		mS
	Off Time		7		mS
FB Hiccup Threshold			0.6		V
High Side Switch On Resistance			190		m Ω
Low Side Switch On Resistance			120		m Ω
High Side Current Limit			3.5		A
SW Leakage Current	$V_{IN}=V_{SW}=12V$			10	μA
EN Rising Threshold	Rising,	1.5	1.6	1.7	V
EN Falling Threshold	Falling	1.3	1.4	1.5	V
EN Input Current	$V_{EN}=2V$		2	6	μA
Thermal Shutdown	Rising, Hysteresis =36°C		150		°C

PIN DESCRIPTION

PIN #	NAME	DESCRIPTION
1	GND	Ground
2	SW	Inductor Connection. Connect an inductor Between SW and the regulator output.
3	IN	Supply Voltage. Bypass with a 10 μ F ceramic capacitor to GND
4	FB	Feedback Input. Connect an external resistor divider from the output to FB and GND to set V _{OUT}
5	EN	Enable pin for the IC. Drive this pin high to enable the part, low or floating to disable.
6	BST	Bootstrap pin. Connect a 10nF capacitor from this pin to SW

TYPICAL CHARACTERISTICS

(Typical values are with C_{ff}=47pF, at T_A = 25°C unless otherwise specified.)

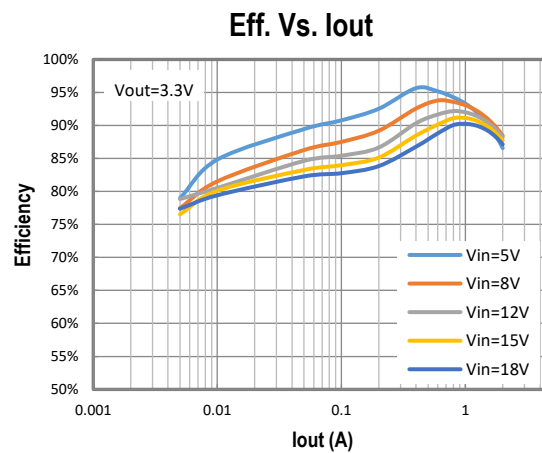
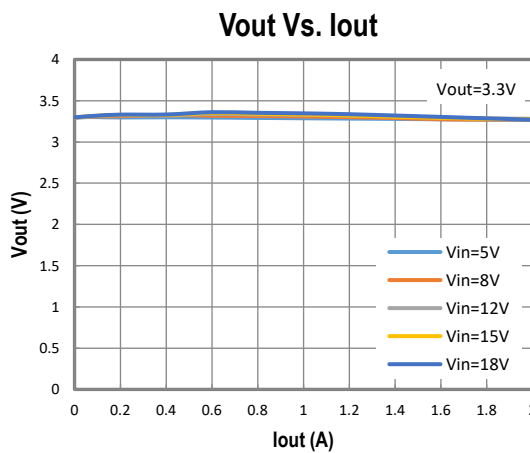
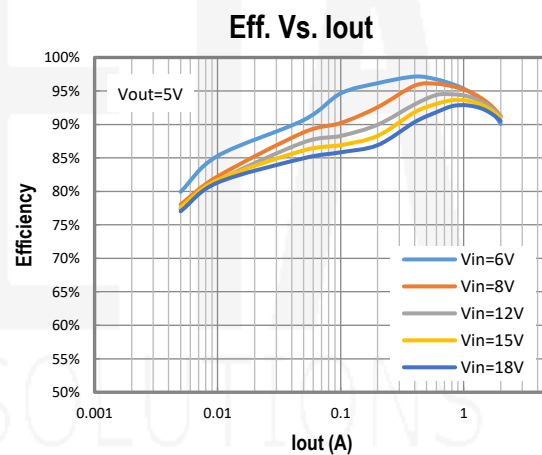
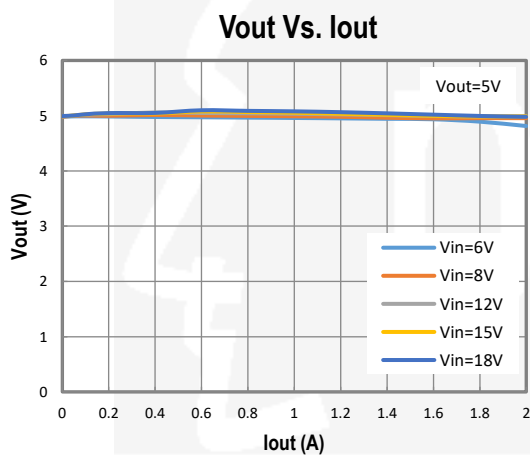

TYPICAL CHARACTERISTICS (cont')

(Typical values are with $C_{ff}=47\text{pF}$, at $T_A = 25^\circ\text{C}$ unless otherwise specified.)

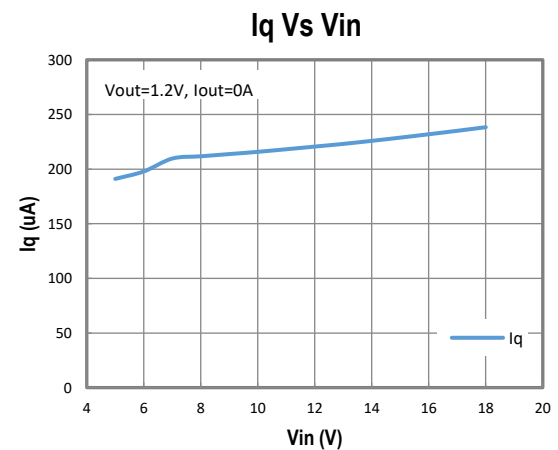
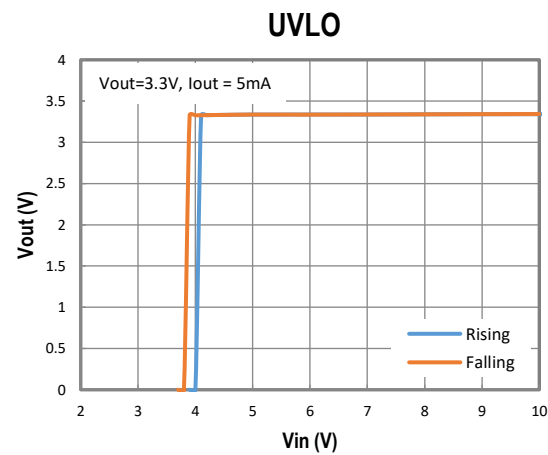
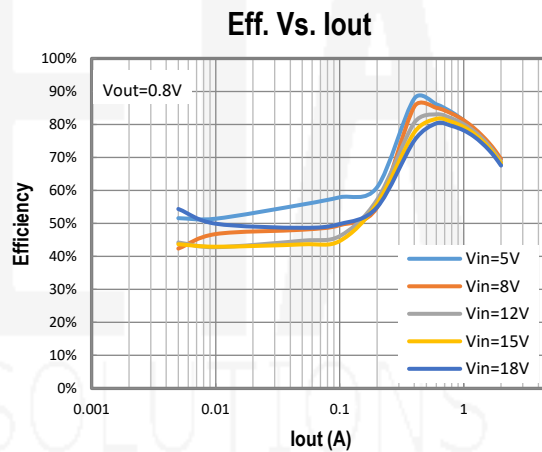
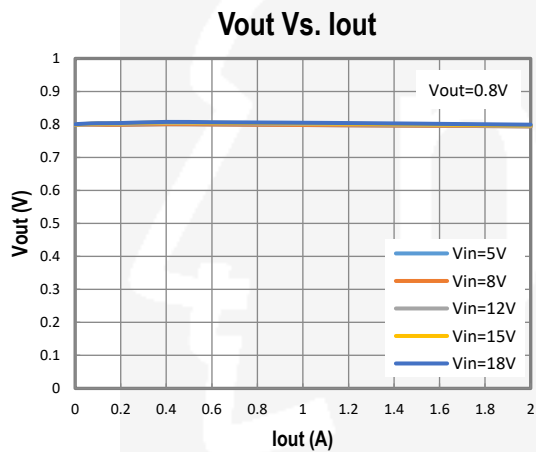
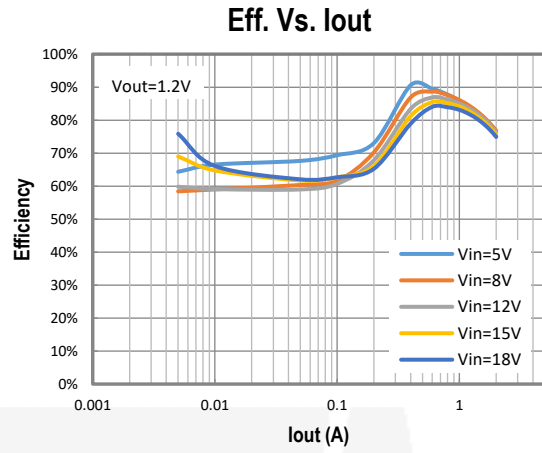
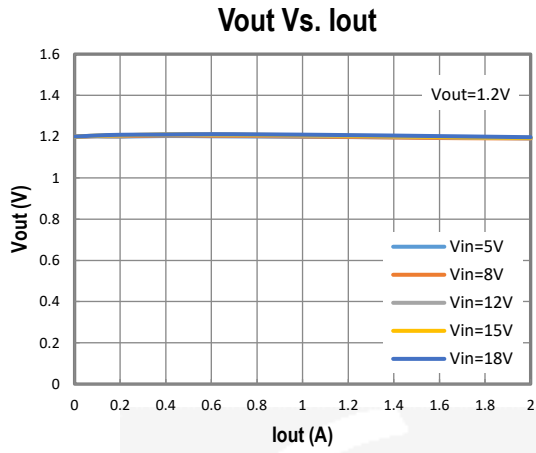

TYPICAL CHARACTERISTICS (cont')

(Typical values are with $C_{ff}=47pF$, at $T_A = 25^\circ C$ unless otherwise specified.)

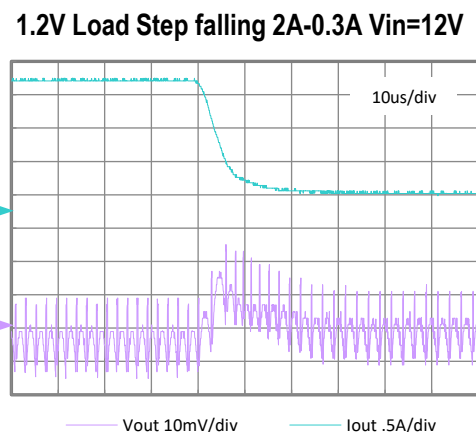
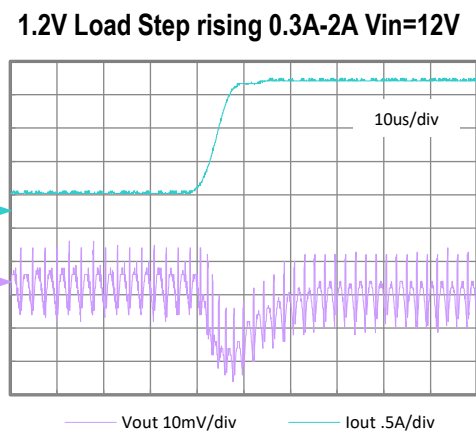
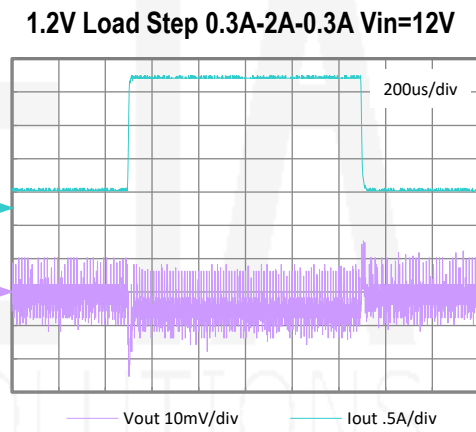
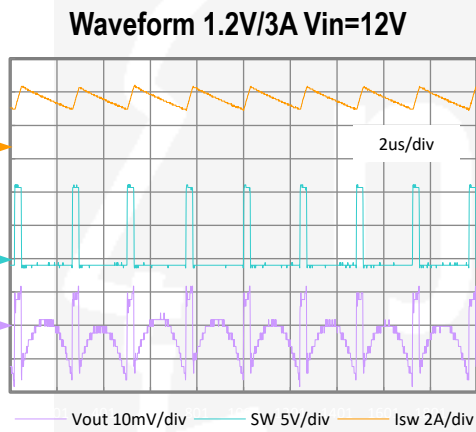
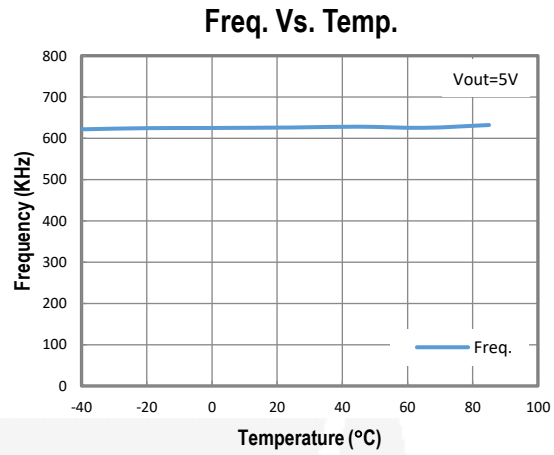
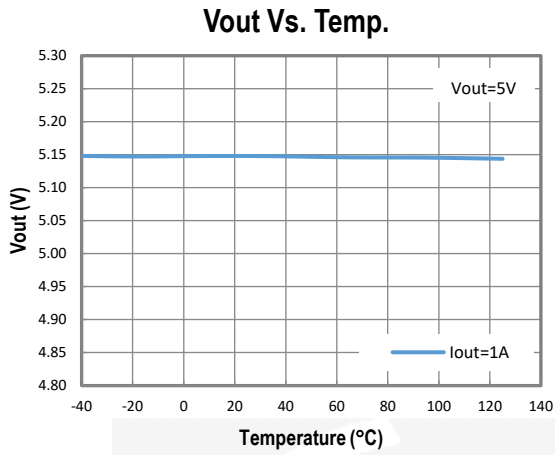

FUNCTIONAL BLOCK DIAGRAM

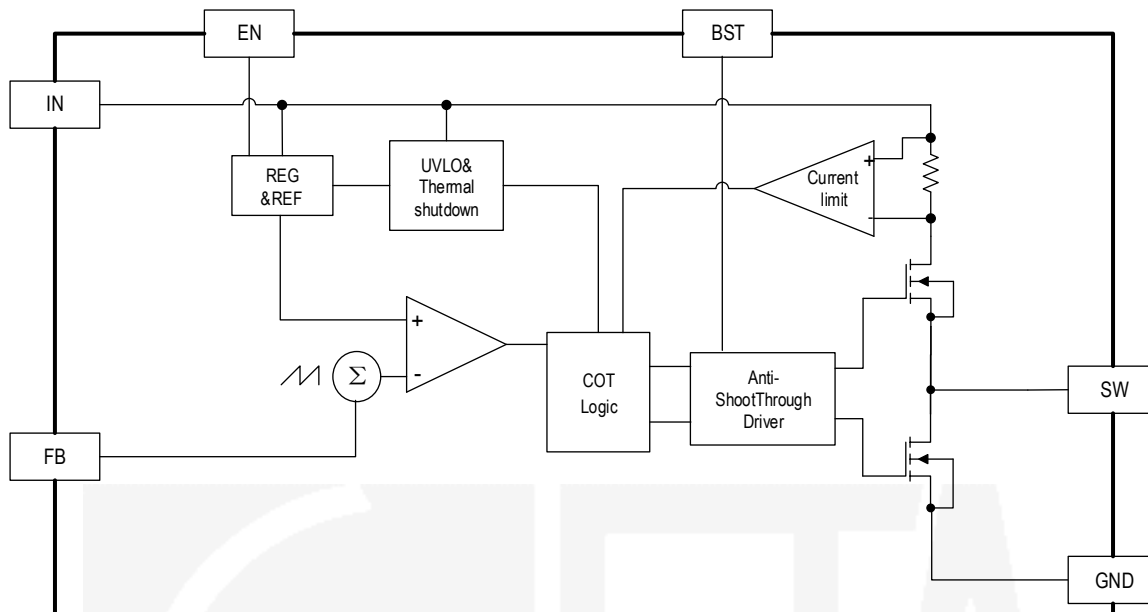

FUNCTIONAL DESCRIPTION

The ETA1477 is a synchronous buck regulator ICs that integrates the adaptive COT control, top and bottom switches on the same die to minimize the switching transition loss and conduction loss.

ETA1477 is a wide input range, high-efficiency and high frequency DC-to-DC step-down switching regulator, capable of delivering up to 2A of output current. It adopts an Adaptive COT control scheme that enables very fast transient response and provides a very smooth transition when the output varies from light load to heavy load. It compares the sum of the FB voltage and a ripple voltage that mimics the voltage due to the output ESR and capacitance. The constant-on-time timer varies with line to achieve relative constant switching frequency across line.

Light Load Operation

Traditionally, a fixed constant frequency PWM DC-DC regulator always switches even when the output load is small. When energy is shuffling back and forth through the power MOSFET, power is lost due to the finite R_{dson} of the MOSFET and parasitic capacitances. At light load, this loss is prominent and efficiency is therefore very low. ETA1477 goes into a power save mode during light load, thereby extending the range of high efficiency operation.

Enable

EN is a digital control pin that turns the ETA1477 on and off. Drive EN High to turn on the regulator, drive it Low to turn it off. An internal $1M\Omega$ resistor from EN pin to GND allows EN to float to shut down the chip. Connecting the EN pin through a pull up resistor or shorted EN to IN will automatically turn on the chip whenever plug in IN.

Over Current Protection and Hiccup

ETA1477 has a cycle-by-cycle over current limit for when the inductor current peak value is over the set current limit threshold. When the output voltage drop until FB falls below UV threshold (0.6V), the ETA1477 will enter hiccup mode. It will turn off the chip immediately for 7mS. After that, it will try to re-start as normal for 1mS. After 1mS, if FB is still below UV threshold, then the chip enters hiccup mode again. If FB is higher than UV threshold, it will enter the normal mode.

Over-Temperature Protection

Thermal protection disables the output when the junction temperature rises to approximately 150°C, allowing the device to cool down. When the junction temperature cools to approximately 110°C, the output circuitry is again enabled. Depending on power dissipation, thermal resistance, and ambient temperature, the thermal protection circuit may cycle on and off. This cycling limits regulator dissipation, protecting the device from damage as a result of overheating.

APPLICATION INFORMATION

External Output Voltage Setting

In external Output Voltage Setting Version selected, the ETA1477 regulator is programmed using an external resistor divider. The output voltage is calculated using below equation.

$$V_{OUT} = V_{REF} \times \left(1 + \frac{R_1}{R_2}\right)$$

Where: VREF = 0.768V typically (the internal reference voltage)

Resistors R2 has to be between 1KOhm to 70KOhm and thus R1 is calculated by following equation.

$$R_1 = \left(\frac{V_{OUT}}{V_{REF}} - 1\right) \times R_2$$

PCB LAYOUT GUIDE

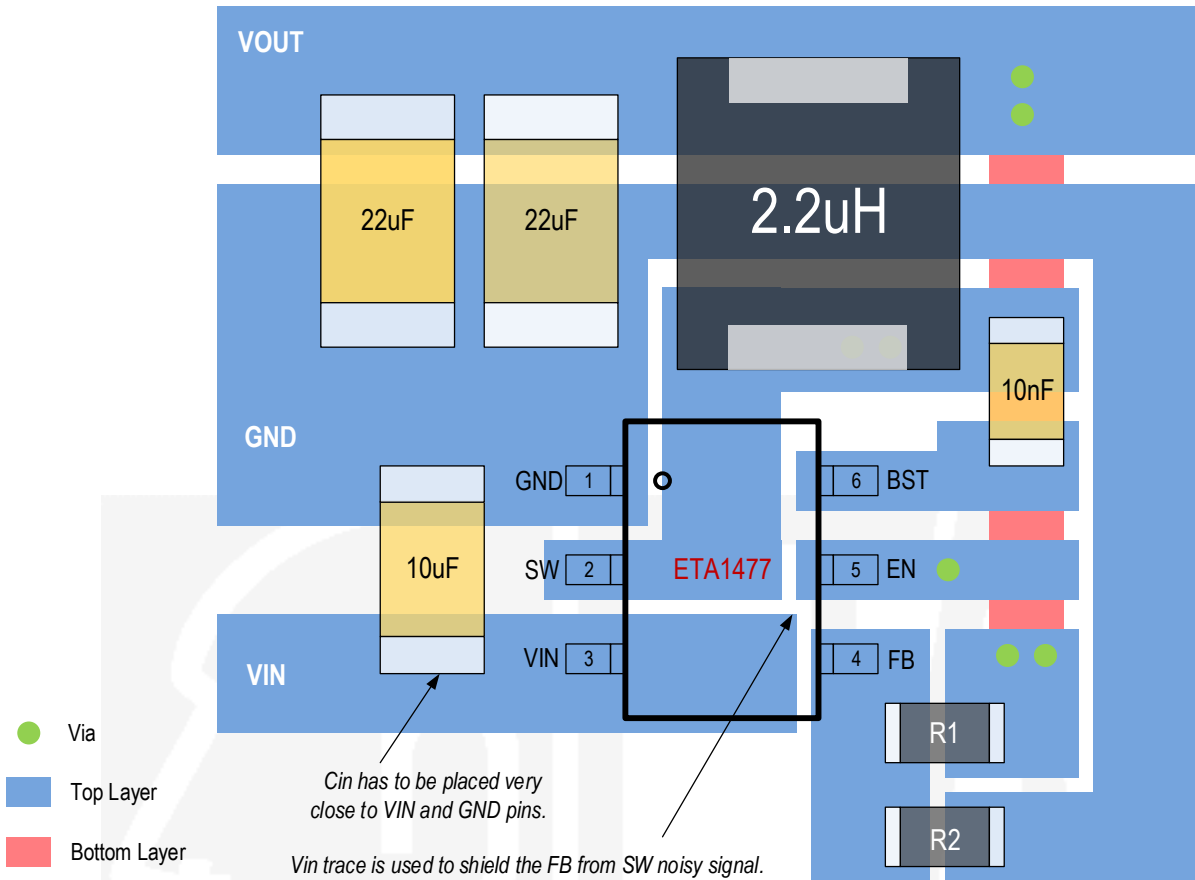

PACKAGE OUTLINE

Package: SOT23-6

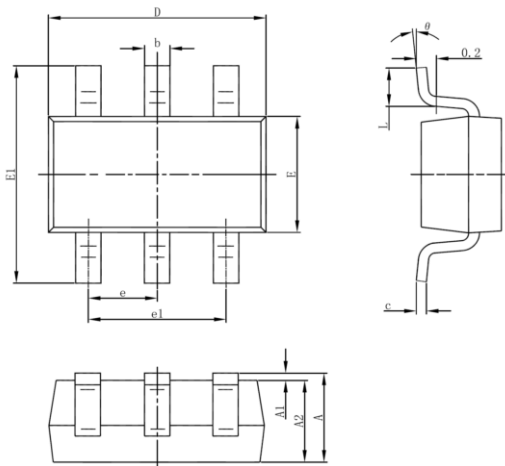

Symbol	Dimensions In Millimeters		Dimensions In Inches	
	Min	Max	Min	Max
A	1.050	1.250	0.041	0.049
A1	0.000	0.100	0.000	0.004
A2	1.050	1.150	0.041	0.045
b	0.300	0.500	0.012	0.020
c	0.100	0.200	0.004	0.008
D	2.820	3.020	0.111	0.119
E	1.500	1.700	0.059	0.067
E1	2.650	2.950	0.104	0.116
e	0.950(BSC)		0.037(BSC)	
e1	1.800	2.000	0.071	0.079
L	0.300	0.600	0.012	0.024
θ	0°	8°	0°	8°

TAPE AND REEL INFORMATION

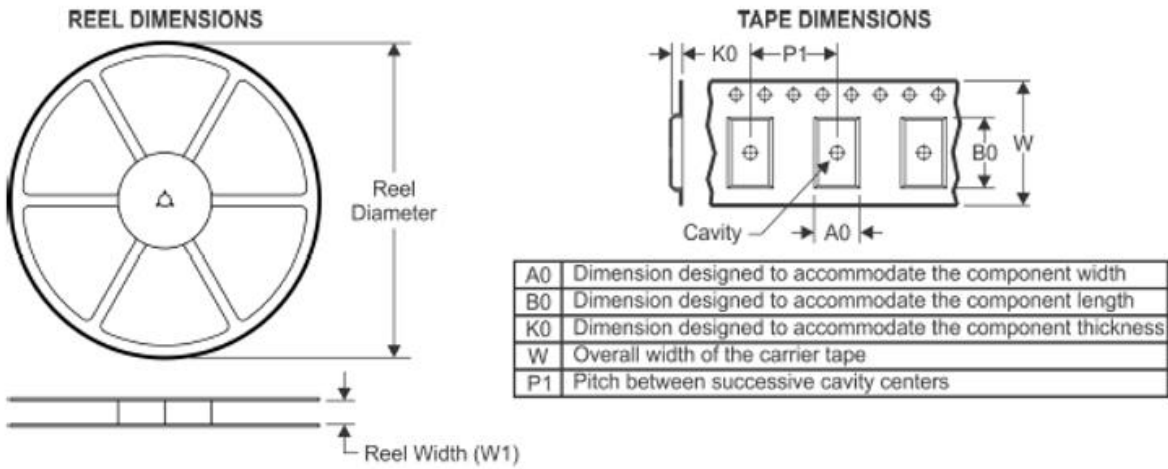

QUADRANT ASSIGNMENTS FOR PIN 1 ORIENTATION IN TAPE

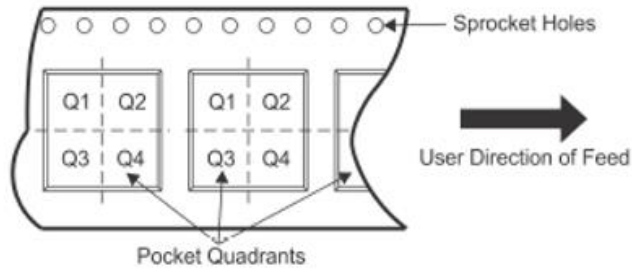

Device	Package Type	Pins	SPQ	Reel Diameter (mm)	Reel Width W1 (mm)	A0 (mm)	B0 (mm)	K0 (mm)	P1 (mm)	W (mm)	Pin1 Quadrant
ETA1477S2G	SOT23-6	6	3000	180	9.5	3.17	3.23	1.37	4	8	Q3

