

High PSRR, 1uA Ultra-Low Iq, 300mA LDO in DFN1x1 and SOT23-5

DESCRIPTION

ETA5071 is a fixed output, low-dropout (LDO) low-power linear voltage regulator that features ultra-low standby current as low as 1uA. It can withstand input voltage up to 7V and delivery 300mA at output. Therefore, ETA5071 is an ideal power supply for low power applications such as IoT, wearables and fingerprint lock, etc.

ETA5071 is available in DFN1x1-4 and SOT23-5.

FEATURES

- ◆ High PSRR, 69dB at 100Hz, 62dB at 1KHz, 48dB at 1MHz
- ◆ 1uA ultra-low Iq
- ◆ 300mA output current
- ◆ Stable with a Wide Range of Ceramic Cap
- ◆ 120mV dropout voltage for 100mA at V_{OUT}=2.8V

APPLICATIONS

- ◆ NB-IoT module
- ◆ Wearables
- ◆ Fingerprint lock

TYPICAL APPLICATION

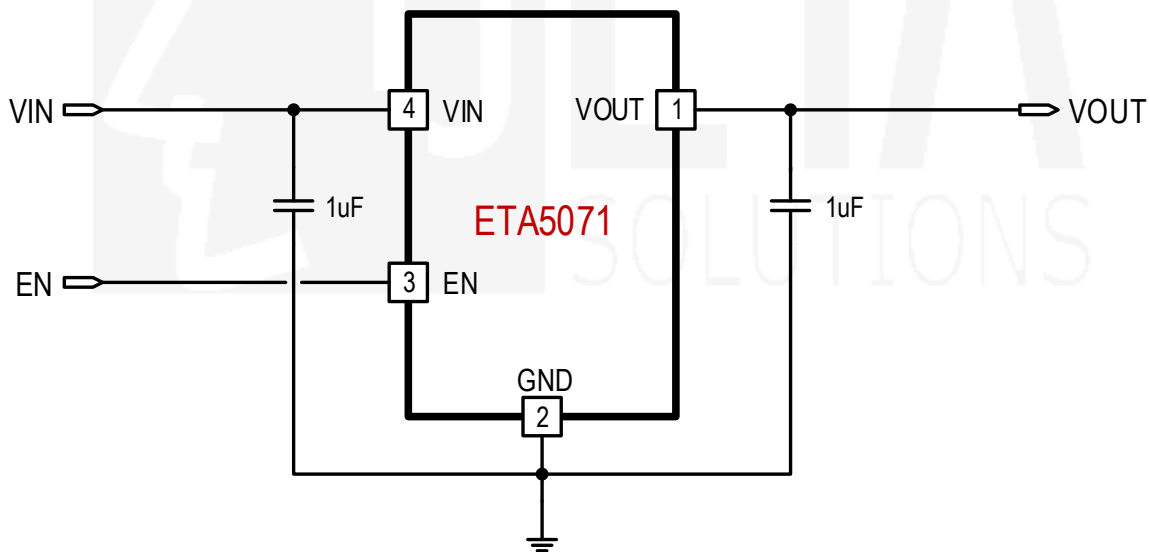

ORDERING

INFORMATION

PART No.	PACKAGE	TOP MARK	Pcs/Reel
ETA5071VXXXOS2F	SOT23-5	PPYW	3000
ETA5071VXXXOD1E	DFN1x1-4	PP YW	10000
ETA5071VXXXOF1E	DFN1x1-4	PP YW	10000

XXX: voltage code *e.g., 120=1.2V*
Q=N: no discharge; *Q=D: discharge*

PP: product code
YW: date code

1.2V No Discharge SOT23-5	ETA5071V120NS2F	SOT23-5	ea <u>YW</u>	3000
1.8V No Discharge SOT23-5	ETA5071V180NS2F	SOT23-5	eb <u>YW</u>	3000
2.8V No Discharge SOT23-5	ETA5071V280NS2F	SOT23-5	ec <u>YW</u>	3000
3.0V No Discharge SOT23-5	ETA5071V300NS2F	SOT23-5	ed <u>YW</u>	3000
3.3V No Discharge SOT23-5	ETA5071V330NS2F	SOT23-5	ee <u>YW</u>	3000
3.6V No Discharge SOT23-5	ETA5071V360NS2F	SOT23-5	ef <u>YW</u>	3000
1.2V Discharge SOT23-5	ETA5071V120DS2F	SOT23-5	eg <u>YW</u>	3000
1.8V Discharge SOT23-5	ETA5071V180DS2F	SOT23-5	eh <u>YW</u>	3000
2.8V Discharge SOT23-5	ETA5071V280DS2F	SOT23-5	ei <u>YW</u>	3000
3.0V Discharge SOT23-5	ETA5071V300DS2F	SOT23-5	ej <u>YW</u>	3000
3.3V Discharge SOT23-5	ETA5071V330DS2F	SOT23-5	ek <u>YW</u>	3000
3.6V Discharge SOT23-5	ETA5071V360DS2F	SOT23-5	el <u>YW</u>	3000
1.2V No Discharge DFN1x1-4	ETA5071V120ND1E	DFN1x1-4	ea <u>YW</u>	10000
1.8V No Discharge DFN1x1-4	ETA5071V180ND1E	DFN1x1-4	eb <u>YW</u>	10000
2.8V No Discharge DFN1x1-4	ETA5071V280ND1E	DFN1x1-4	ec <u>YW</u>	10000
3.0V No Discharge DFN1x1-4	ETA5071V300ND1E	DFN1x1-4	ed <u>YW</u>	10000
3.3V No Discharge DFN1x1-4	ETA5071V330ND1E	DFN1x1-4	ee <u>YW</u>	10000
3.6V No Discharge DFN1x1-4	ETA5071V360ND1E	DFN1x1-4	ef <u>YW</u>	10000
1.2V Discharge DFN1x1-4	ETA5071V120DD1E	DFN1x1-4	eg <u>YW</u>	10000
1.8V Discharge DFN1x1-4	ETA5071V180DD1E	DFN1x1-4	eh <u>YW</u>	10000
2.8V Discharge DFN1x1-4	ETA5071V280DD1E	DFN1x1-4	ei <u>YW</u>	10000
3.0V Discharge DFN1x1-4	ETA5071V300DD1E	DFN1x1-4	ej <u>YW</u>	10000
3.3V Discharge DFN1x1-4	ETA5071V330DD1E	DFN1x1-4	ek <u>YW</u>	10000
3.6V Discharge DFN1x1-4	ETA5071V360DD1E	DFN1x1-4	el <u>YW</u>	10000
1.2V No Discharge DFN1x1-4	ETA5071V120NF1E	DFN1x1-4	ea <u>YW</u>	10000
1.8V No Discharge DFN1x1-4	ETA5071V180NF1E	DFN1x1-4	eb <u>YW</u>	10000
2.8V No Discharge DFN1x1-4	ETA5071V280NF1E	DFN1x1-4	ec <u>YW</u>	10000

3.0V No Discharge DFN1x1-4	ETA5071V300NF1E	DFN1x1-4	ed <u>YW</u>	10000
3.3V No Discharge DFN1x1-4	ETA5071V330NF1E	DFN1x1-4	ee <u>YW</u>	10000
3.6V No Discharge DFN1x1-4	ETA5071V360NF1E	DFN1x1-4	ef <u>YW</u>	10000
1.2V Discharge DFN1x1-4	ETA5071V120DF1E	DFN1x1-4	eg <u>YW</u>	10000
1.8V Discharge DFN1x1-4	ETA5071V180DF1E	DFN1x1-4	eh <u>YW</u>	10000
2.8V Discharge DFN1x1-4	ETA5071V280DF1E	DFN1x1-4	ei <u>YW</u>	10000
3.0V Discharge DFN1x1-4	ETA5071V300DF1E	DFN1x1-4	ej <u>YW</u>	10000
3.3V Discharge DFN1x1-4	ETA5071V330DF1E	DFN1x1-4	ek <u>YW</u>	10000
3.6V Discharge DFN1x1-4	ETA5071V360DF1E	DFN1x1-4	el <u>YW</u>	10000

PIN CONFIGURATION

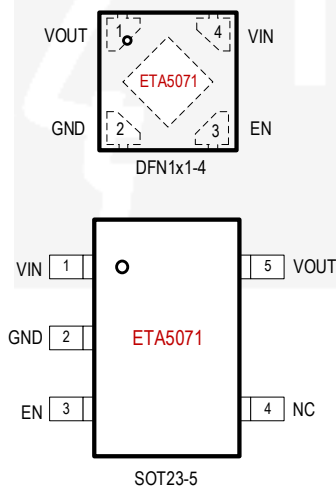

ABSOLUTE MAXIMUM RATINGS

(Note: Exceeding these limits may damage the device. Exposure to absolute maximum rating conditions for long periods may affect device reliability.)

VIN, EN, VOUT Voltage	-0.3V to 7V		
Operating Temperature Range	-40°C to 85°C		
Storage Temperature Range	-55°C to 150°C		
Thermal Resistance	θ_{JA}	θ_{JC}	
SOT23-5	180	90	°C/W
DFN1x1-4	120	60	°C/W
Lead Temperature (Soldering 10sec)	260°C		
ESD LU (Latch-up)	100mA		

ELECTRICAL CHARACTERISTICS

($V_{IN} = V_{OUT} + 1V$, unless otherwise specified. Typical values are at $T_A = 25^\circ C$.)

PARAMETER	CONDITIONS	MIN	TYP	MAX	UNIT
Input Voltage Range ⁽¹⁾		1.8		6.5	V
Ground Current	$V_{EN} = V_{IN}$, No Load		1		μA
Shutdown Current	$V_{EN} = 0V$, $1.8V \leq V_{IN} \leq 5.5V$			0.3	μA

Dropout Voltage	$I_{OUT} = 100\text{mA}, V_{OUT} = 2.8\text{V}$	0.12	V
Output Current Limit	$V_{OUT} = 95\%$	350 500	mA
Output Foldback Current Limit	$V_{OUT} = 0\text{V}$	120	mA
Line Regulation	$V_{OUT} + 1\text{V} \leq V_{IN} \leq 5.5\text{V}$	0.2	%/V
Load Regulation	$0\mu\text{A} \leq I_{OUT} \leq 300\text{mA}$	20	mV
Output Voltage Range	Available in 100mV steps	1 3.6	V
Vout Voltage accuracy	$I_{OUT} = 30\text{mA}, V_{OUT} > 1.8\text{V}$	-2 +2	%
Power Supply Rejection Ratio	Freq = 100Hz, $I_{OUT} = 10\text{mA}, V_{OUT} = 1.2\text{V}$	69	dB
	Freq = 1kHz, $I_{OUT} = 10\text{mA}, V_{OUT} = 1.2\text{V}$	62	
	Freq = 1MHz, $I_{OUT} = 10\text{mA}, V_{OUT} = 1.2\text{V}$	48	
	Freq = 100Hz, $I_{OUT} = 10\text{mA}, V_{OUT} = 1.8\text{V}$	64	
	Freq = 1kHz, $I_{OUT} = 10\text{mA}, V_{OUT} = 1.8\text{V}$	59	
	Freq = 1MHz, $I_{OUT} = 10\text{mA}, V_{OUT} = 1.8\text{V}$	42	
Start-up time		70	μs
EN pin input Logic Low	$1.8\text{V} \leq V_{IN} \leq 5.5\text{V}$	0.4	V
EN pin input Logic High	$1.8\text{V} \leq V_{IN} \leq 5.5\text{V}$	1.2	V
Input current at EN pin	$V_{EN} = V_{IN}$	0	μA
Pulldown Resistor	Output Discharge Version	60	Ω
Thermal Shutdown	Rising, Hysteresis = 10°C	150	$^\circ\text{C}$

(1): Minimum V_{IN} is 1.8V or $V_{OUT} + V_{DROPOUT}$, whichever is greater.

PIN DESCRIPTION

DFN1x1-4 PIN #	SOT23-5 PIN#	NAME	DESCRIPTION
1	5	VOUT	Output of regulator
2	2	GND	Ground Pin
3	3	EN	Enable Pin. Drive it high to enable IC, drive it low to disable. EN can be connected to IN if not used.
4	1	VIN	Input Supply Pin
	4	NC	Not Connected

TYPICAL CHARACTERISTICS

(Typical values are at $T_A = 25^\circ\text{C}$ unless otherwise specified.)

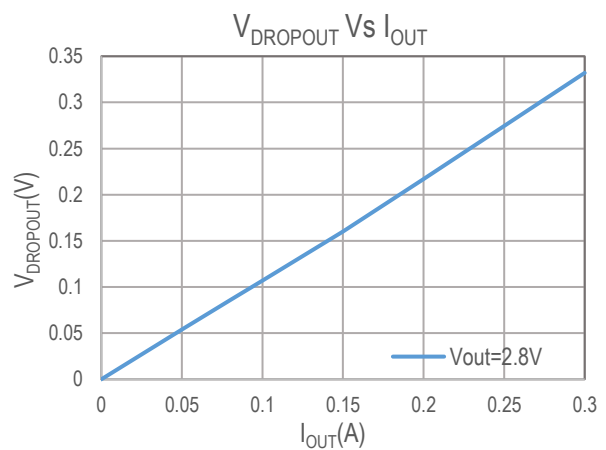
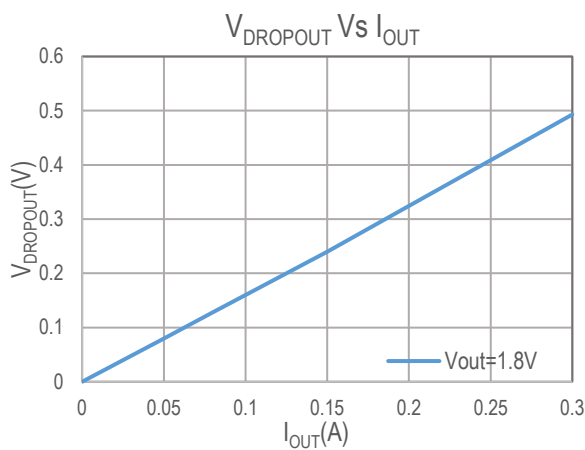
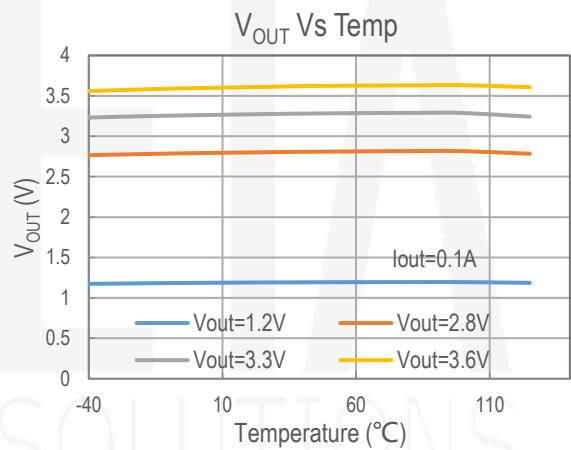
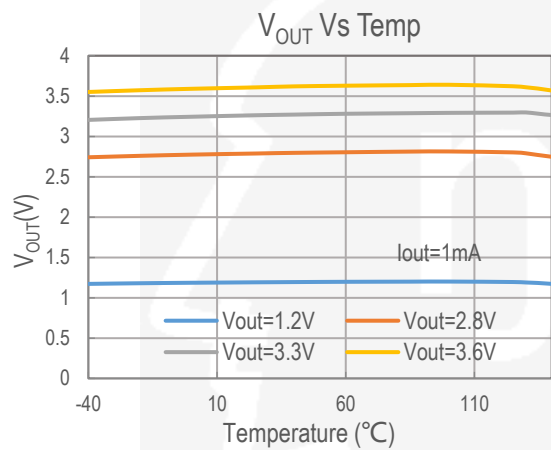
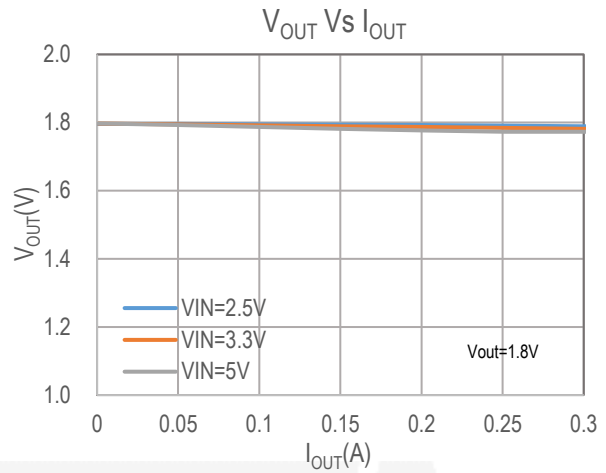
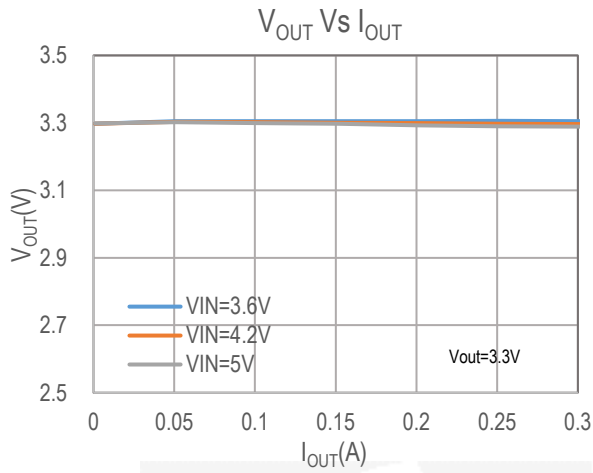

TYPICAL CHARACTERISTICS (cont')

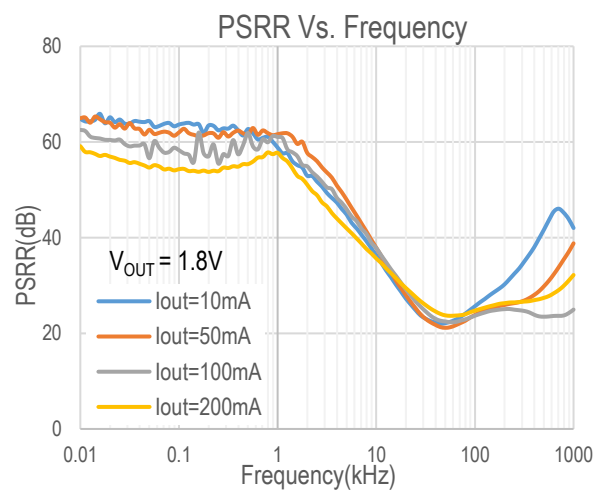
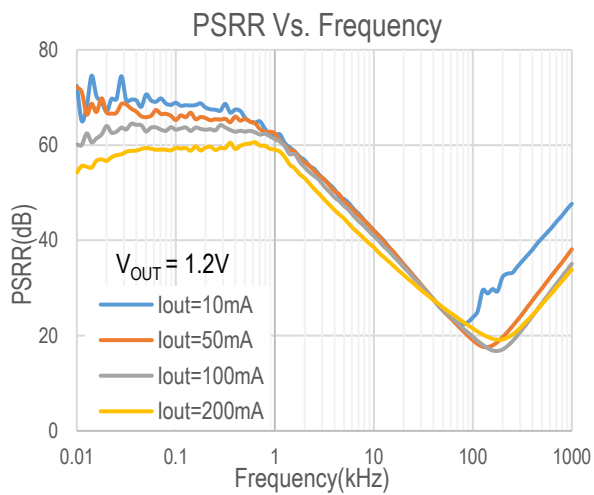
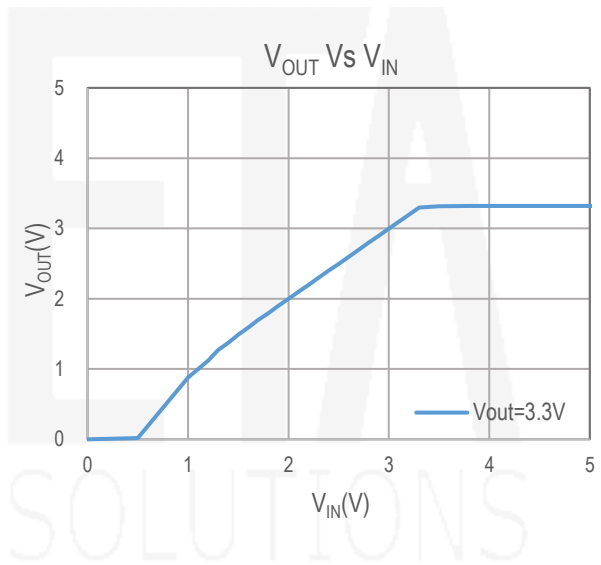
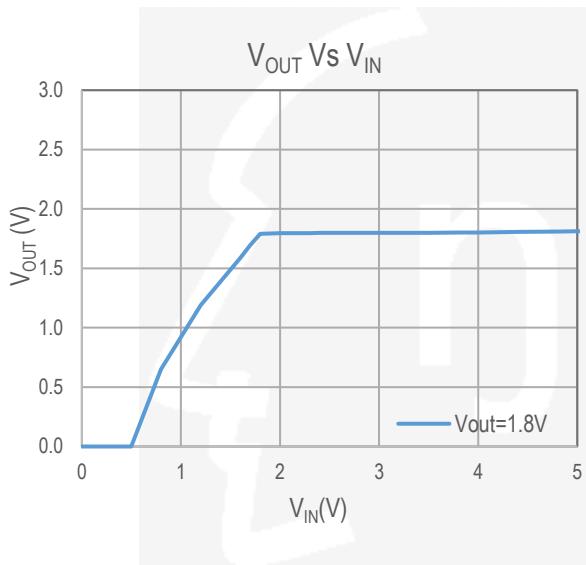
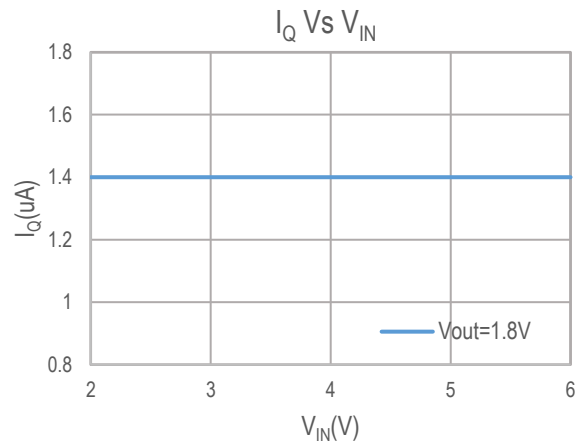
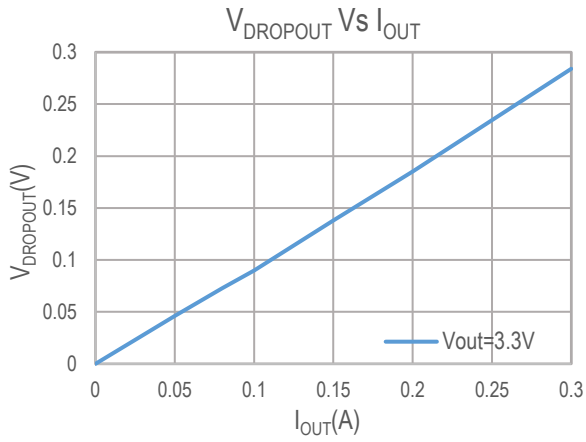

TYPICAL CHARACTERISTICS (cont')

Load Transient Response

$V_{IN}=3.8V$, $V_{OUT}=1.8V$, $I_{OUT}=50-100mA$

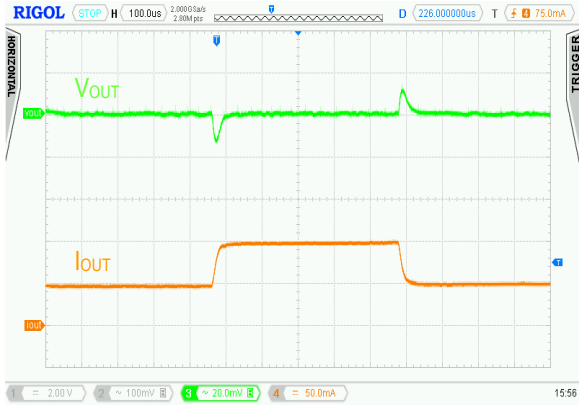

Startup Waveforms

$V_{IN}=3.8V$, $V_{EN}=2V$, $V_{OUT}=3.3V$, $I_{OUT}=100mA$

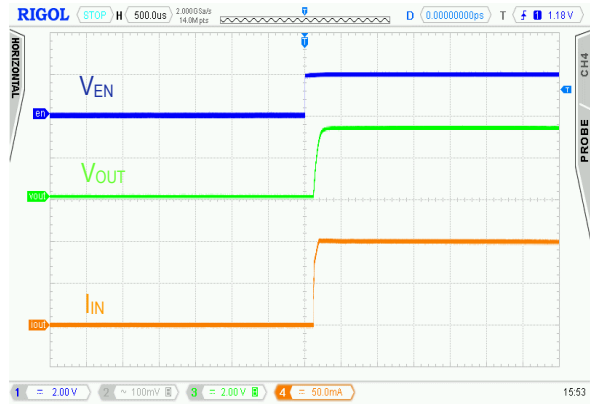

Load Transient Response

$V_{IN}=3.8V$, $V_{OUT}=1.8V$, $I_{OUT}=1-300mA$

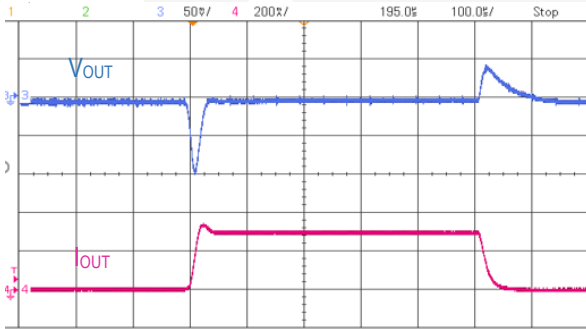

Line Transient Response

$V_{IN}=2.8V-3.8V$, $V_{OUT}=1.8V$, $I_{OUT}=1mA$

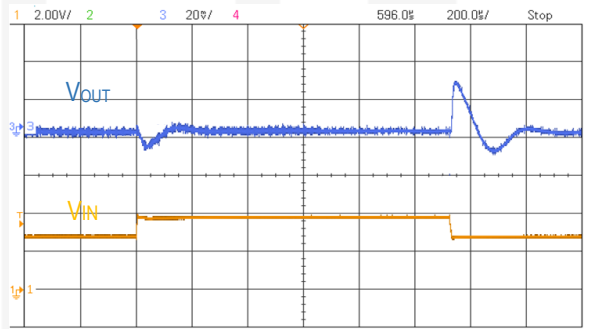

Power ON from EN

$V_{IN}=3.8V$, $V_{EN}=3.8V$, $V_{OUT}=1.8V$, $I_{OUT}=300mA$

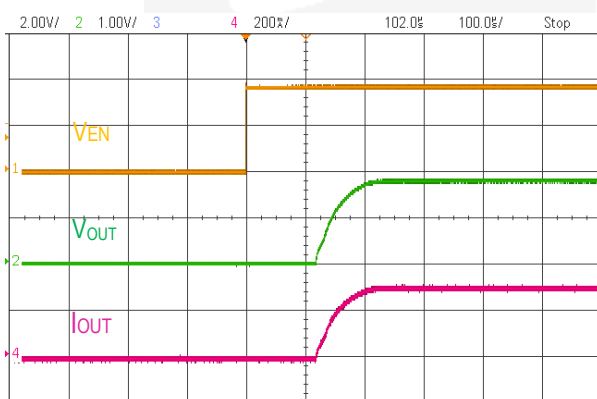

Power Off from EN

$V_{IN}=3.8V$, $V_{EN}=3.8V$, $V_{OUT}=1.8V$, $I_{OUT}=300mA$

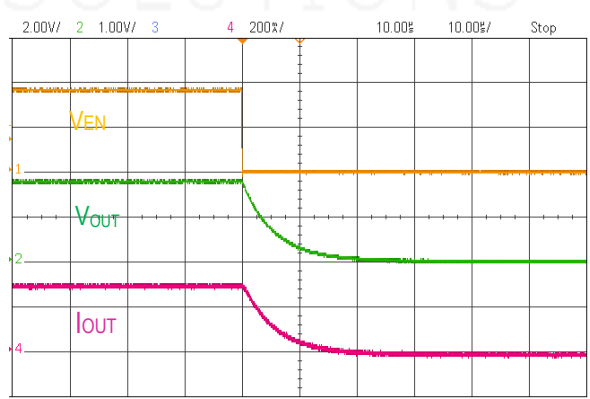

FUNCTIONAL BLOCK DIAGRAM

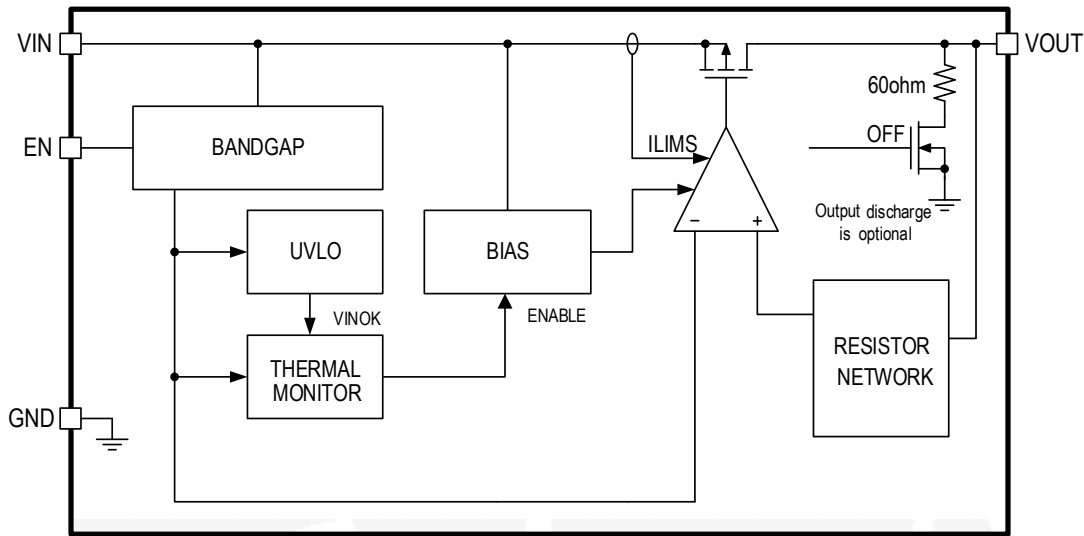

FUNCTIONAL DESCRIPTION

The ETA5071 family of LDO regulators has been optimized for application in low standby power equipment. The device features ultra-low quiescent current, and 5V input voltage with 300mA output current capability.

Enable Sequence

ETA5071 is enabled when all below conditions happen. Otherwise, ETA5071 is in standby mode.

- ◆ EN pin voltage above logic High level
- ◆ Junction Temperature is not at Over-Temperature Protection level.

Once all above conditions happen, ETA5071 first enables BANDGAP and BIAS then enables LDO core.

ETA5071 is in shutdown mode when EN pin is pulled below logic low level threshold. The shutdown current is less than 0.3uA in at that time. Otherwise, part only shutdown the VOUT while other circuit still in operation. Once ETA5071 is in shutdown conditions, Output is discharged by 60Ω resistor (optional).

Output Current Limit and Foldback Current Limit

ETA5071 family features an internal current limit. In normal operation, the ETA5071 limits output current to approximately 500mA. When current limiting engages, the output voltage scales back linearly until the over current condition ends.

In case output is in hard short conditions, ETA5071 also features an internal foldback limit that reduces the output current limit to a lower level, 120mA, then reduce power dissipation ratings of the package.

Over-Temperature Protection

Thermal protection disables the output when the junction temperature rises to approximately 170°C, allowing the device to cool down. When the junction temperature cools to approximately 140°C, the output circuitry is again enabled. Depending on power dissipation, thermal resistance, and ambient temperature, the thermal protection circuit may cycle on and off. This cycling limits regulator dissipation, protecting the device from damage as a result of overheating.

PACKAGE OUTLINE

Package: SOT23-5
 ETA5055VXXXQS2F

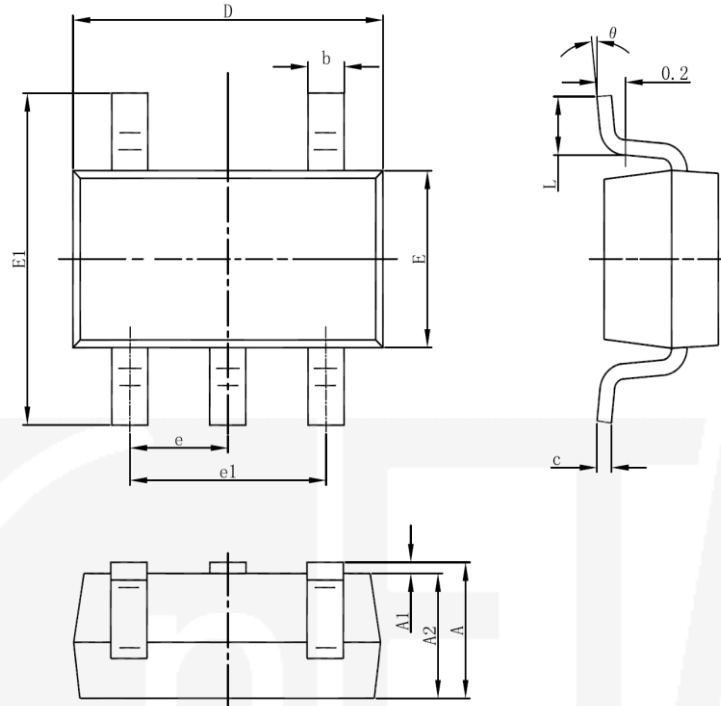

Symbol	Dimensions In Millimeters		Dimensions In Inches	
	Min	Max	Min	Max
A	1.050	1.250	0.041	0.049
A1	0.000	0.100	0.000	0.004
A2	1.050	1.150	0.041	0.045
b	0.300	0.500	0.012	0.020
c	0.100	0.200	0.004	0.008
D	2.820	3.020	0.111	0.119
E	1.500	1.700	0.059	0.067
E1	2.650	2.950	0.104	0.116
e	0.950(BSC)		0.037(BSC)	
e1	1.800	2.000	0.071	0.079
L	0.300	0.600	0.012	0.024
θ	0°	8°	0°	8°

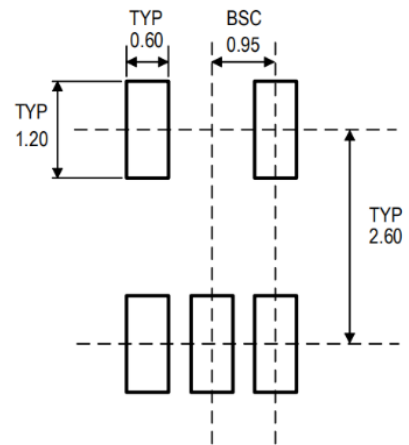

RECOMMENDED LAND PATTERN

Package: DFN1x1-4

From assembly house1: ETA5055VXXXQF1E

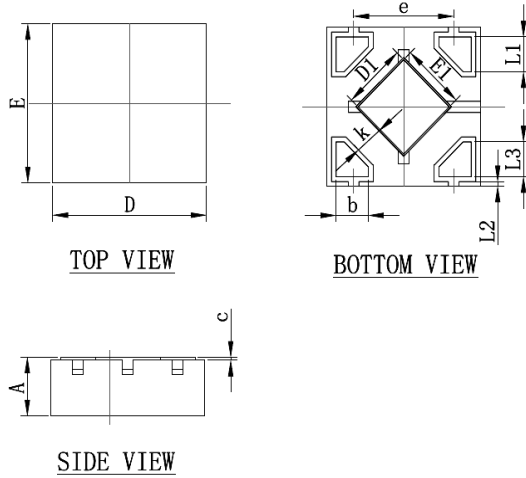

Symbol	Dimensions in Millimeters		Dimensions in Inches	
	Min.	Max.	Min.	Max.
A	0.335	0.400	0.013	0.016
D	0.950	1.050	0.037	0.041
E	0.950	1.050	0.037	0.041
D1	0.370	0.470	0.015	0.019
E1	0.370	0.470	0.015	0.019
k	0.17MIN.		0.007MIN.	
b	0.160	0.260	0.006	0.010
c	0.010	0.090	0.000	0.004
e	0.600	0.700	0.024	0.028
L1	0.185	0.255	0.007	0.010
L2	0.030 REF.		0.001 REF.	
L3	0.185	0.255	0.007	0.010

From assembly house2: ETA5055VXXXQD1E

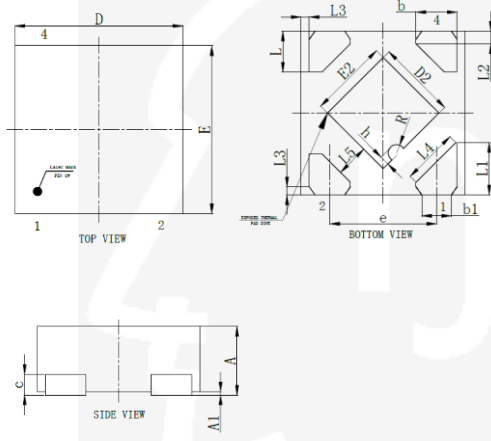

SYMBOL	MILLIMETER		
	MIN	NOM	MAX
A	0.35	-	0.40
A1	0.00	0.02	0.05
b	0.20	0.25	0.30
b1	0.13	0.18	0.23
c	0.07	0.12	0.17
D	0.95	1.00	1.05
D2	0.43	0.48	0.53
e	0.65BSC		
E	0.95	1.00	1.05
E2	0.43	0.48	0.53
L	0.20	0.25	0.30
L1	0.27	0.32	0.37
L2	0.077REF		
L3	0.05REF		
L4	0.34REF		
L5	0.20REF		
R	0.05REF		
h	0.06REF		

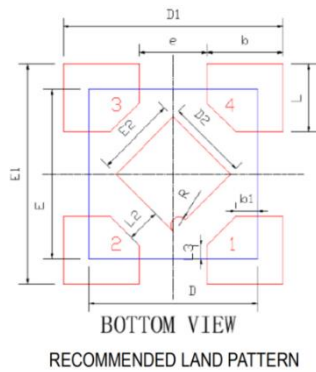

Dimensions	Value (in mm)
D	1
E	1
D1	1.3
E1	1.3
D2	0.48
E2	0.48
R	0.05
e	0.4
b	0.45
L	0.4
b 1	0.13
L3	0.08
L2	0.2(\geq 0.2)

TAPE AND REEL INFORMATION

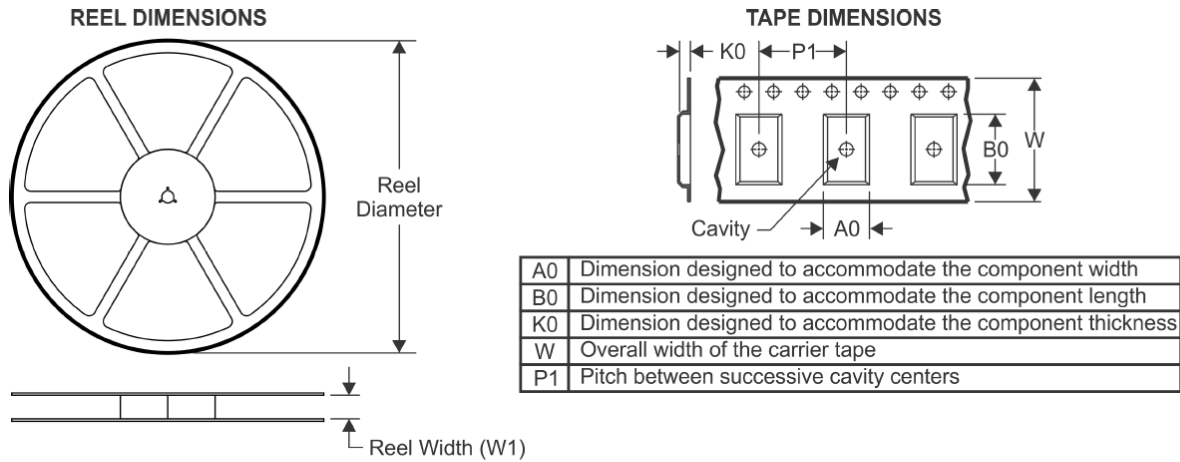

QUADRANT ASSIGNMENTS FOR PIN 1 ORIENTATION IN TAPE

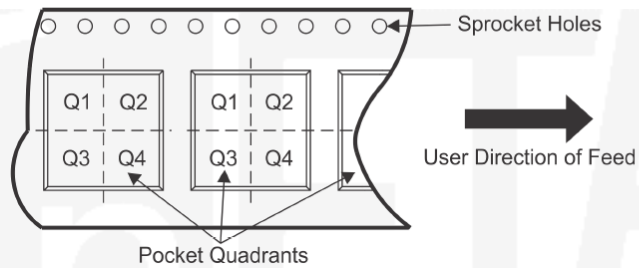

Device	Package Type	Pins	SPQ	Reel Diameter (mm)	Reel Width W1 (mm)	A0 (mm)	B0 (mm)	K0 (mm)	P1 (mm)	W (mm)	Pin1 Quadrant
ETA5071VXXXQD1E	DFN1*1-4	4	10000	180	9.5	1.16	1.16	0.5	2	8	Q1
ETA5071VXXXOF1E	DFN1*1-4	4	10000	180	9.5	1.16	1.16	0.5	2	8	Q1
ETA5071VXXXQS2F	SOT23-5	5	3000	180	9.5	3.17	3.23	1.37	4	8	Q3